

Preparation

Part Number: PT533-34070

NOTE: Part number of this accessory may not be the same as the part number shown.

Kit Contents

Item #	Quantity Req'd.	Description
1	1	Alloy Wheel
2	1	Hardware Bag
3	1	Care Card
4	1	Installation Instruction

Hardware Bag Contents

Item #	Quantity Req'd.	Description
1	1	Center Cap (PT533-34070-CC)

Additional Items Required For Installation

Item #	Quantity Req'd.	Description
1	As Required	Balance Weights Stick-on Type (Hoffman Standard)
2	As Required	Balance Weights Clip-on Type (Hoffman Standard)
3	1 per wheel	TPMS Sensor, 42607-0C070 (for "Styled" steel wheel)
4	4	Lug Nuts, PT533-3407B (5 pc.)
5	4	Dunlop SP Sport 5000 P275/55R20, DT001-34070
6	As Required	TPMS Fitting Kit, 04423-0C170
7	1	Tire Pressure Label 00107-00399

Conflicts

Tundra 20" Factory Alloy Wheel

Recommended Tools

Personal & Vehicle Protection	Notes
Safety Glasses	
Seat Protection	Blanket
Special Tools	Notes
Wheel Balancing Machine	Hunter GSP9700 or equiv.
Tire Mounting Machine	Hunter TC3250 or equiv.
Centering Cone	Hunter 192-170-2
Wheel Spacer	Hunter 46-433-2
Foot Brake Application Tool	Snap-on B240A Pedal Jack or equiv.
Toyota Diagnostic Tester Kit	P/N TOY220036 with 01002593-005 Tester Program Card with Version 12.1a software (or later)
CAN Interface Module Kit	01002744

Installation Tools	Notes
Lug Nut Wrench	
Rubber Mallet	
Torque Wrench	0-250 lbf-ft (340 N-m)
Torque Wrench	0-75 lbf-in (8.5 N-m)
Socket	22 mm Deep Well
Clean Lint-free Cloth	
Nylon Panel Removal Tool	e.g. Panel Pry Tool #1 Toyota SST # 00002-06001-01
Socket	12 mm Thin Wall, Deep Well
Infrared Temperature Probe	
Heat Gun	
Special Chemicals	Notes
Tire Lube	
Cleaner (for rework only)	VDC approved cleaner

General Applicability

Tundra with 18" Styled Steel Wheel (requires new TPMS)
Tundra with 18" Regular Steel Wheel (reuse factory TPMS)

Recommended Sequence of Application

Item #	Accessory
1	Alloy Wheel
2	Wheel Lock

*Mandatory

Vehicle Service Parts (may be required for reassembly)

Item #	Quantity Req'd.	Description
1		

Legend

 **STOP:** Damage to the vehicle may occur. Do not proceed until process has been complied with.

 **OPERATOR SAFETY:** Use caution to avoid risk of injury.

 **CAUTION:** A process that must be carefully observed in order to reduce the risk of damage to the accessory/vehicle and to ensure a quality installation.

 **TOOLS & EQUIPMENT:** Used in Figures calls out the specific tools and equipment recommended for this process.

 **REVISION MARK:** This mark highlights a change in installation with respect to previous issue.

 **SAFETY TORQUE:** This mark indicates that torque is related to safety.

Care must be taken when installing this accessory to ensure damage does not occur to the vehicle. The installation of this accessory should follow approved guidelines to ensure a quality installation.

These guidelines can be found in the "Accessory Installation Practices" document.



This document covers such items as:-

- Vehicle Protection (use of covers and blankets, cleaning chemicals, etc.).
- Safety (eye protection, rechecking torque procedure, etc.).
- Vehicle Disassembly/Reassembly (panel removal, part storage, etc.).
- Electrical Component Disassembly/Reassembly (battery disconnection, connector removal, etc.).

Please see your Toyota dealer for a copy of this document.

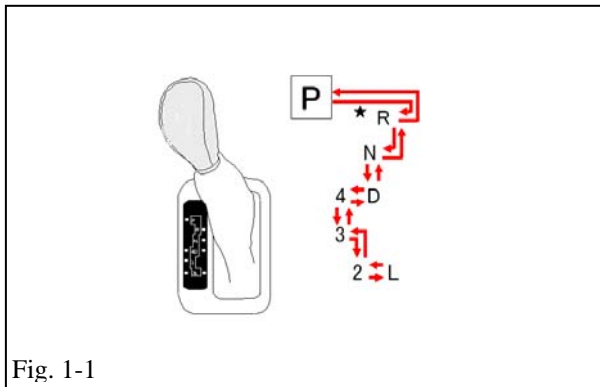
1. Vehicle Preparation



-  (a) Firmly apply parking brake.
-  (b) Put automatic transmission in "P." (Fig. 1-1).

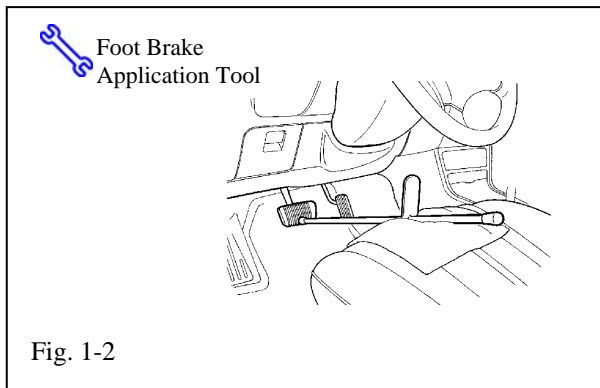

- (c) Add seat protection (blanket) and apply foot brake using foot brake application tool. (Fig. 1-2).
- (d) Lift vehicle.

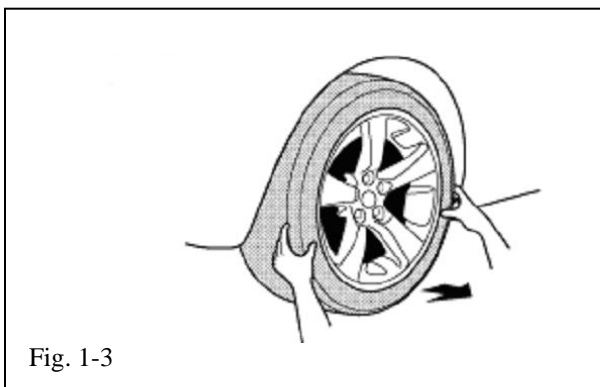

-  (e) Remove OE wheel and tire assembly from vehicle (Fig. 1-3). Wear safety glasses while removing wheels.

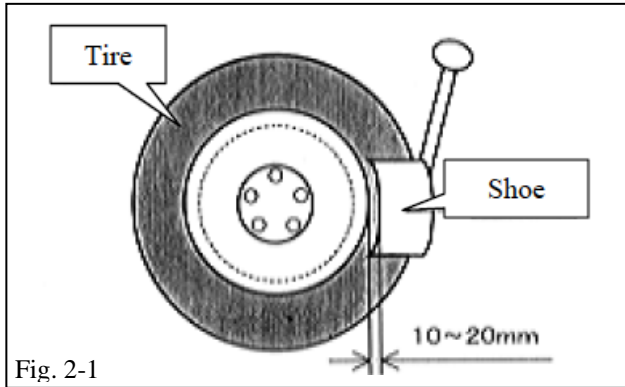

Fig. 2-1



- (a) Remove the valve core and release pressure from the tire.
- (b) Remove the nut and washer. Retain for reinstallation later. Let the pressure sensor drop inside the tire.
- (c) Carefully separate the upper tire bead from the wheel rim. (Fig. 2-1).



NOTE: Be careful not to damage the tire pressure monitor due to interference between the sensor and tire bead.

- (d) Remove the sensor from the tire and remove the bead on the lower side as in usual tire removal operation.

- (e) Dismount OE tire from the OE wheel.

3. Install Tire Pressure Monitor Valve

- (a) Visually check that there is no deformation or damage on the tire pressure monitor valve sub-assembly (use TPMS 42607-0C070 for styled steel wheel).

- (b) Check that the rim is clean.

- (c) Change the original grommet to a new one if the grommet is damaged.



NOTE: Damaged grommet is NOT reusable.

- (d) Check that the grommet, washer and nut are clean.



- (e) Record TPMS Transmitter ID No. and verify that the number is copied accurately (for "Styled" steel wheel). (Fig. 3-1)

- (f) Insert the tire pressure monitor valve sub-assembly into the valve installation hole from the inside of the rim and bring the valve stem to the outside. (Fig. 3-2).

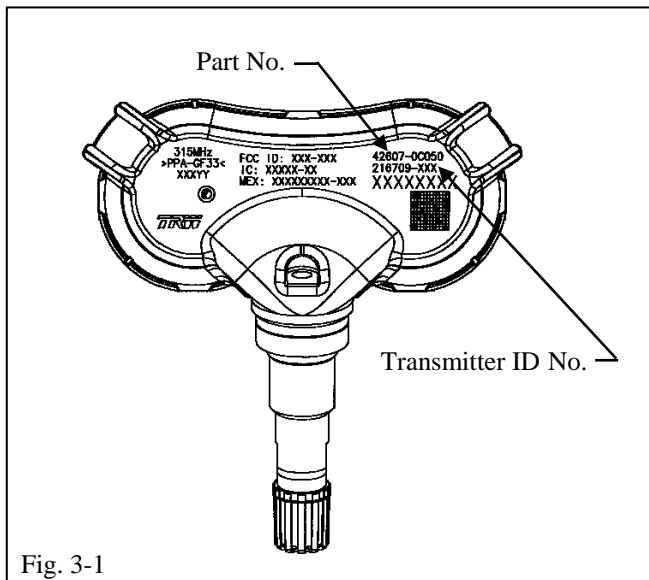

Fig. 3-1

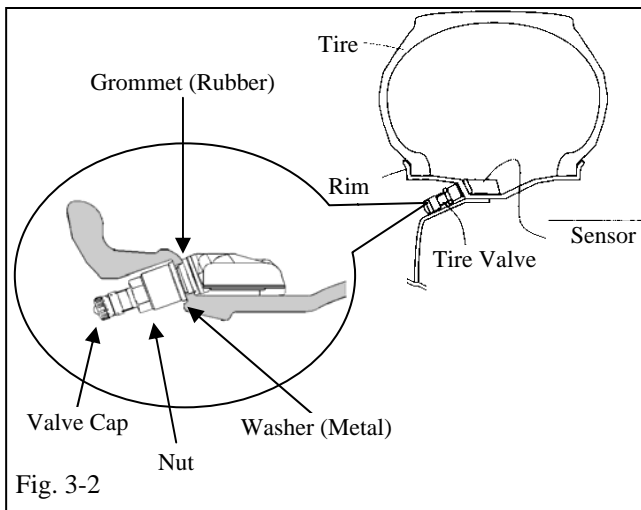

Fig. 3-2

- (g) Insert the tire pressure monitor valve sub-assembly so that manufacturer mark is visible.

STOP **NOTE:** Incorrect orientation of pressure monitor sub-assembly may cause damage and prevent signal transmission during high-speed running.

- (h) Install the washer and secure with the nut.

! (i) Tighten the nut to 4.0 N-m (36 lbf-in)

4. Tire Mounting

- (a) Use tire lube on tire bead and bead location on wheel prior to mounting the tire.

- (b) Position the wheel on the mounting machine with the sensor at ~ 7 o'clock position (shaded area in Fig. 4-1)

- (c) Mount/dismount head is considered as 12 o'clock position.

- (d) Mount the lower tire bead.

STOP **NOTE:** If the sensor is positioned outside this area, it generates interference with the tire bead, causing possible damage to the sensor.

- (e) Reposition the wheel on the mounting machine with the sensor at ~5 o'clock position (shaded area in Fig. 4-2)

- (f) Mount upper tire bead.

STOP **NOTE:** Make sure that the tire bead and tool do not interfere with the main body of the sensor and the bead does not clamp the sensor.

- +** (g) To seat tire bead, inflate tire beyond 33 PSI but not more than the maximum tire bead seat pressure indicated on the tire sidewall. If it is not indicated use 40 PSI as a limit. If tire bead is not seated when pressure registers 40 PSI, deflate the tire and re-inflate to seat the bead. Regulate tire pressure to 33 PSI.

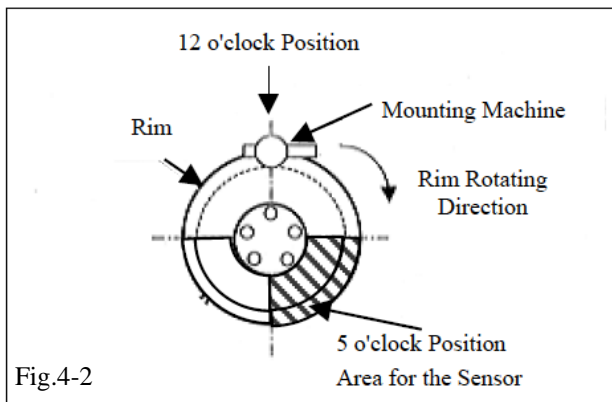
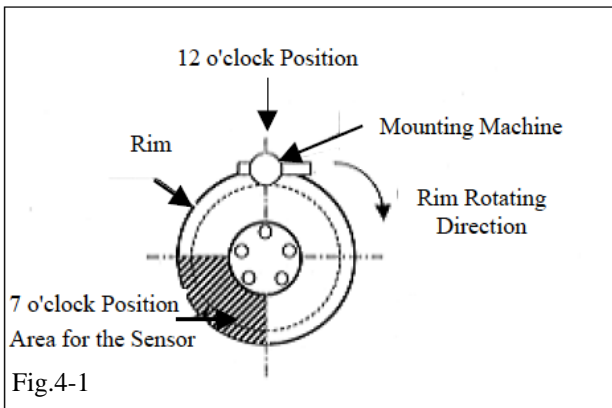



- (h) After inflating the tire, re-tighten the nut of tire pressure monitor valve sub-assembly to 4.0 +/- 0.6 N-m (36 +/- 5.3 lbf-in).

5. Wheel Balancing

NOTES: This wheel requires stick-on weight on outer rim and clip-on weight on inner rim for balancing. Application temperature for stick-on type weight: above 10°C (50°F). It is good practice to apply the stick type weights in section comprising no more than 5 or 6 individual weight segments.

- (a) Mount wheel/tire on wheel balance machine and balance in DYNAMIC MODE. Enable the LOAD ROLLER, if applicable (enabling the load roller ensures proper bead seating). Use clip-on type balance weight on the inner rim lip and stick-on type weights at outer rim location. (Fig. 5-1 & Fig. 5-2)
- (b) Prior to mounting stick on type, wipe down the wheel weight mounting location on wheel with a clean lint-free dry cloth. Ensure that location is clean and dry. Apply stick-on weights at perimeter location identified by dynamic balance machine, as shown. Use rubber mallet, if required, to achieve complete adhesion of stick-on type weight.

NOTES: Maximum clip-on type weight on inner lip is 140 g. Maximum stick-on type weight at outer location is 140 g. If removal and replacement of stick-on type weight is necessary, remove the weights using a nylon removal tool. Clean the surface with a clean cloth and VDC approved cleaner. Wipe the surface dry before re-applying a new weight. **(DO NOT RE-USE STICK-ON WEIGHTS.)**

- (c) ROLLER DISABLED (if applicable) and note the indicated remainder unbalance. The maximum permitted unbalance is 8 g at inner lip and 8 g at outer location.

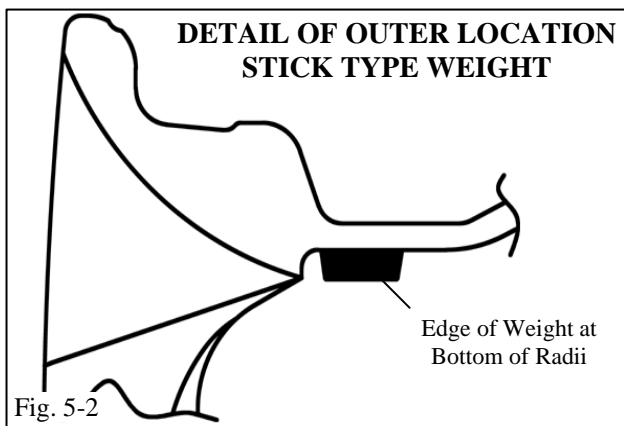
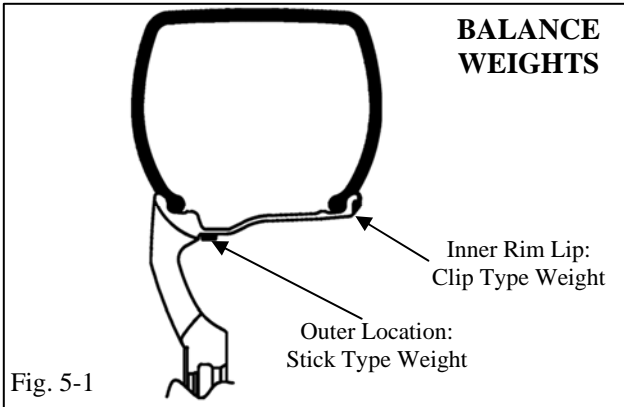

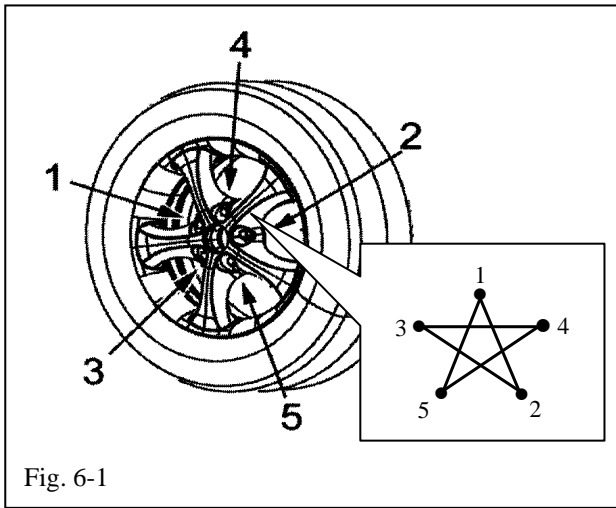





Fig. 6-1

6. Vehicle Wheel/Tire and Center Cap Installation

-  (a) Install wheel/tire assembly on vehicle. Hand start the lug nuts during installation. Tighten lug nuts in sequence 1 through 5 (Fig. 6-1). Ensure that the socket does not scuff the wheel. Tighten to 131N-m (97 lbf-ft) using a torque wrench.
- (b) Lower the vehicle.
-  (c) Tire pressure should be adjusted to the value recommended on the tire pressure label (Section 9) for this vehicle. Install valve stem cap.
-  (d) Install the center cap. Gently push cap into wheel until cap snaps into place.

7. TPMS Transmitter ID No. Listing Using Hand Held Tester (when replacing Styled steel wheel)

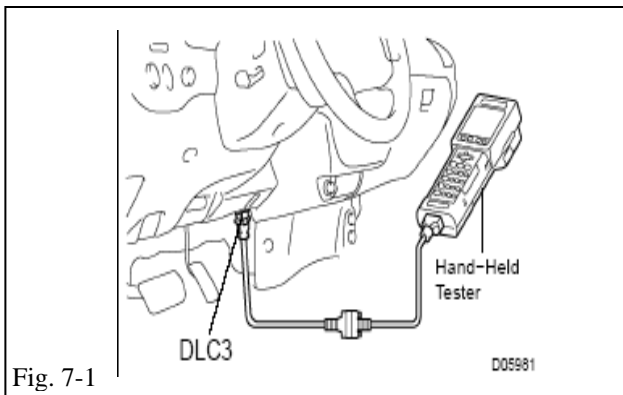



Fig. 7-1

- (a) Complete this section (and section 8) after all four wheels have been installed.
- (b) Connect the hand-held tester to DLC3. (Fig. 7-1)
-  (c) Turn the ignition switch to the ON position.
- (d) Following the display on the hand-held tester, select the "DATA LIST." (Fig. 7-2)
- (e) Record the sensor ID of the sensor which still registers a pressure.
- (f) **Or** lower the spare tire and record the sensor ID number on a sticker near the tire valve. Raise the spare tire into the storage position.

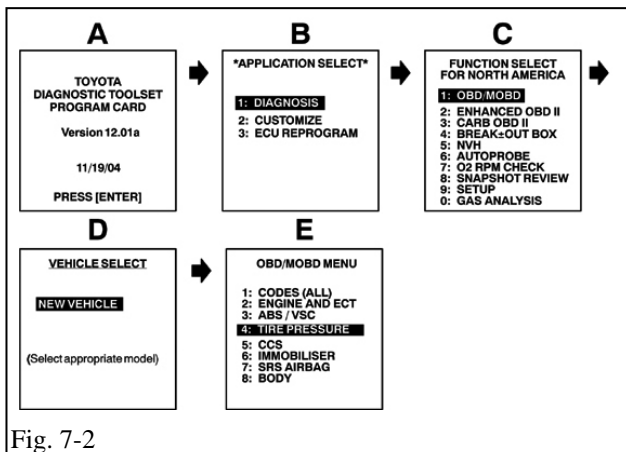

Fig. 7-2

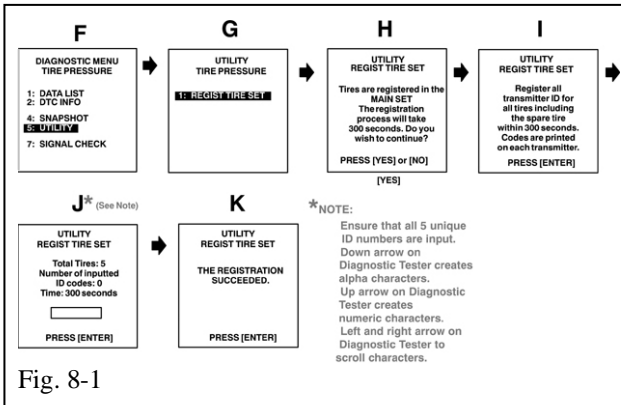

Fig. 8-1

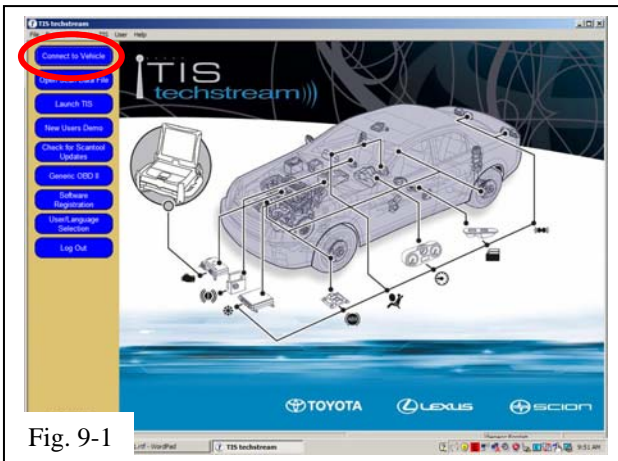

Fig. 9-1

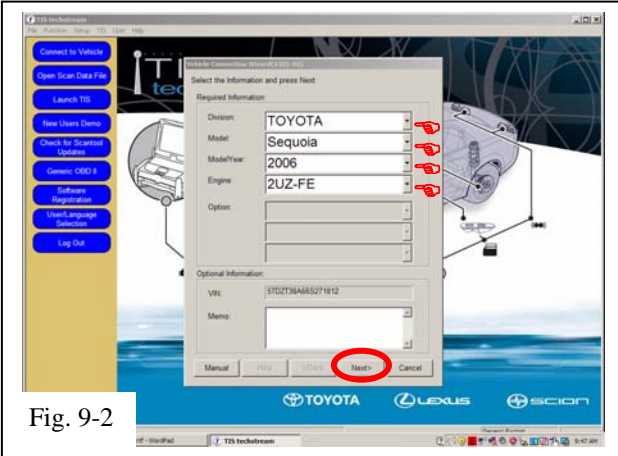

Fig. 9-2

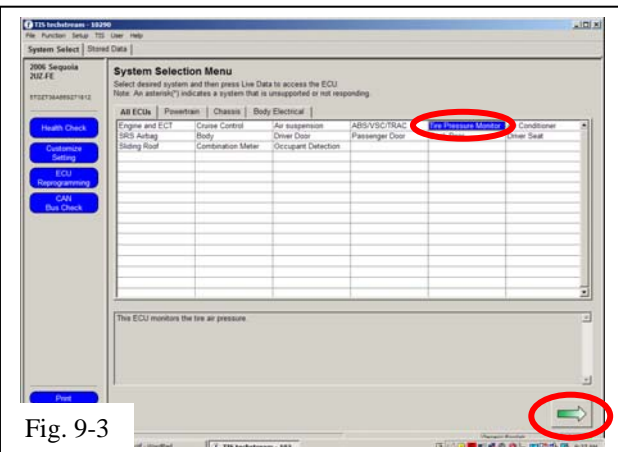

Fig. 9-3

8. TPMS Transmitter ID Registration

- Select the REGIST TIRE following the hand-held tester screen. (Fig. 8-1) (UTILITY – REGIST TIRE)
- Input the ID (ID1 to ID5) from Steps 3(e) and 7(e) using the hand-held tester and transmit it to the tire pressure monitor ECU.
- Set the ID transmission condition to “SUCCEEDED”.
- Confirm all the tire pressures are set to values recommended on the tire pressure label (Section 11.) for this vehicle.



NOTE: If this process is not completed within 5 minutes, the transmitter will return to normal operation mode.

9. TPMS Transmitter ID No. Listing Using Techstream (when replacing Styled steel wheel)

- Connect the Techstream to DLC3.
- Turn the ignition switch to ON position (do not start the vehicle) then turn the Techstream ON.
- Start the Techstream application by clicking on the shortcut located on the Desktop.
- Click “Connect to Vehicle” button. (Fig. 9-1)
- Confirm that the information displayed on the Vehicle Connection Wizard is correct. If not make the appropriate selections from the Drop Down Menus then click Next. (Fig. 9-2)
- Select “Tire Pressure Monitor” Then click the green arrow located on the bottom right. (Fig. 9-3)

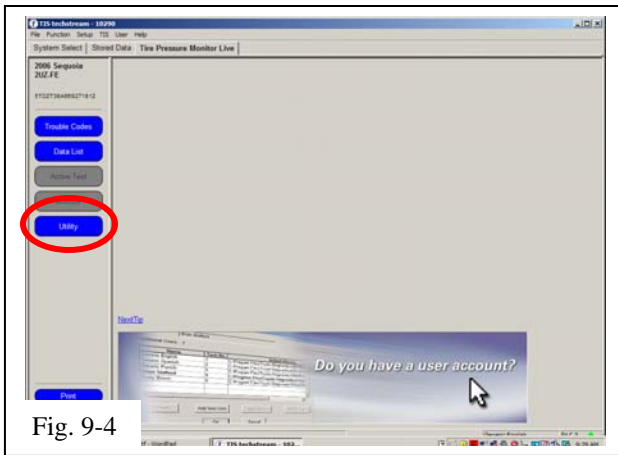

Fig. 9-4

- (g) Select “Utility” to begin input of new TPMS ID codes (Fig. 9-4)
- (h) Select “ID Registration” then click the green arrow located at the bottom right corner. (Fig. 9-5)
- (i) Select “Next” for Steps 1 through 3. Select “Input” in Step 4 to begin TPMS ID registration. (Fig. 9-6)

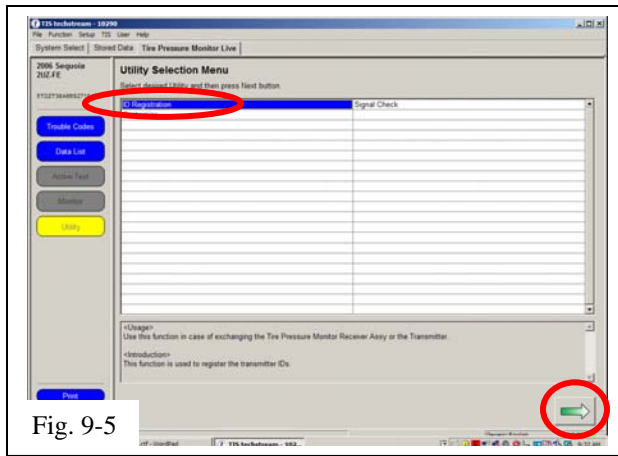

Fig. 9-5

- (j) Input the TPMS ID code then click OK. Repeat the same procedure for all other TPMS ID codes. (Fig. 9-7)



NOTE: If this process is not completed within 5 minutes, the transmitter will return to normal operation mode.

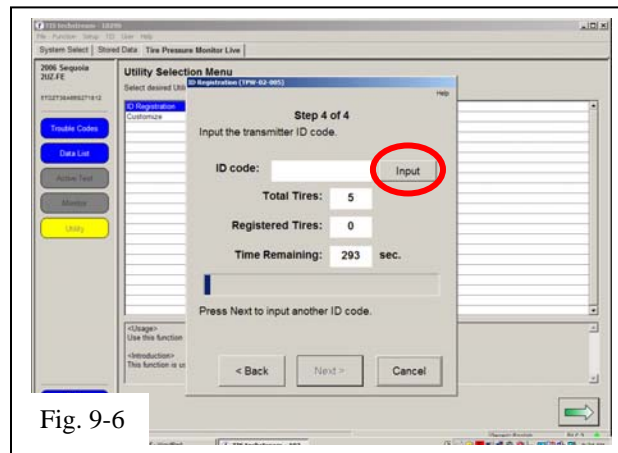

Fig. 9-6

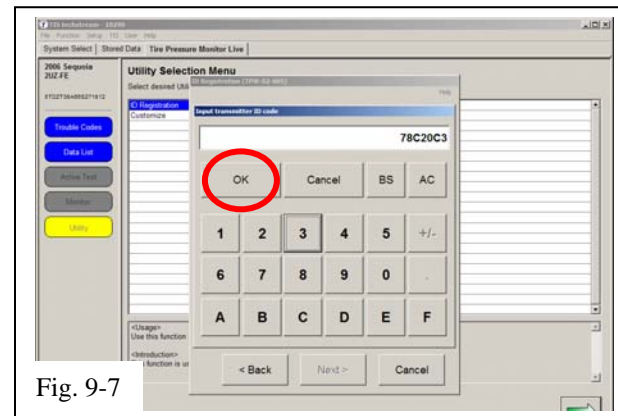

Fig. 9-7

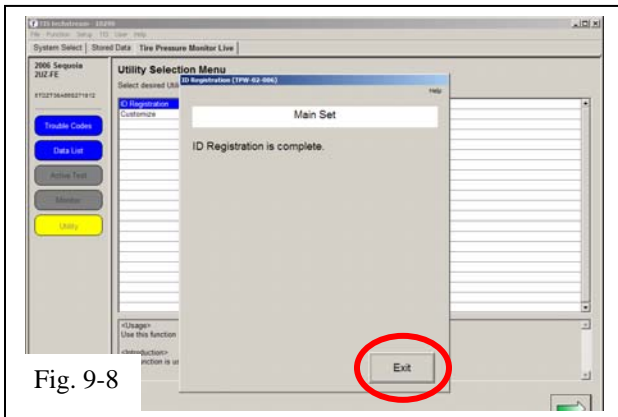

Fig. 9-8

(k) After all TPMS ID have been registered, click “Exit” to end the registration process. (Fig. 9-8)

(l) Select “Data List” to view and confirm the TPMS ID has been correctly registered. (Fig. 9-9)

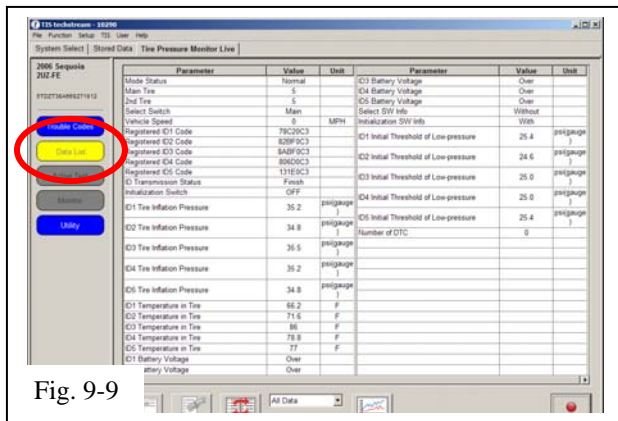

Fig. 9-9

10. Tire Registration

(a) Follow the procedure in the PPO Bulletin “Tundra Tire Registration”.

11. Tire Pressure Label

- (a) Clean the surface of the OE tire pressure label.
- (b) Align the 20” wheel tire pressure label over the tire size of the OE label (Fig. 11-1).
- (c) Affix the 20” tire pressure label.

12. Care Card

(a) Place the care card in the vehicles glove box.

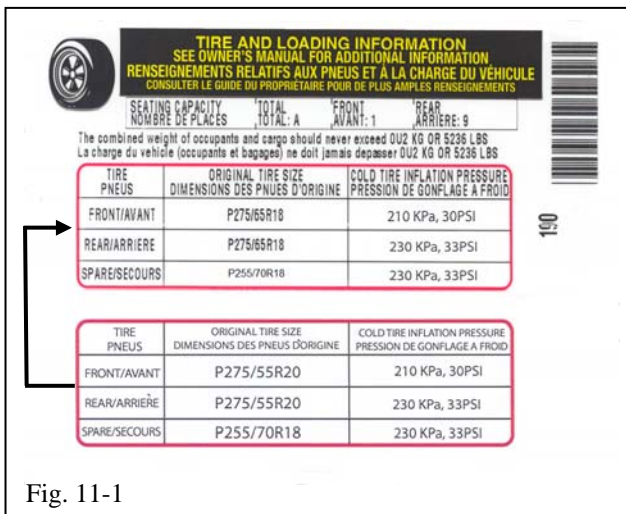



Fig. 11-1

Checklist - these points **MUST** be checked to ensure a quality installation.

Check:

- Inspect lug nuts.
- Lug nut tightness
-  Correct Tire Pressure
- Label Placement
- Care Card

Look For:

Five lug nuts must be installed on each wheel.

Lug nuts have been installed at a torque value of 131N-m (97 lbf-ft). Verify process only. Check torque during installation.

Verify tire pressure is: 30 PSI Front and 33 PSI Rear \pm 2 PSI.

Tire Pressure Label is affixed over OE Tire Pressure Label on the door jam.

Care card is in the glove box.